

Bastelbogen Nr. 831q

Rundlaterne (mit Halterung)

Durchmesser : 18 cm
Höhe : 29,5 cm

Seiten : 11
Anzahl der Teile : 20 + 9

Schwierigkeit: S4 mittelschwer

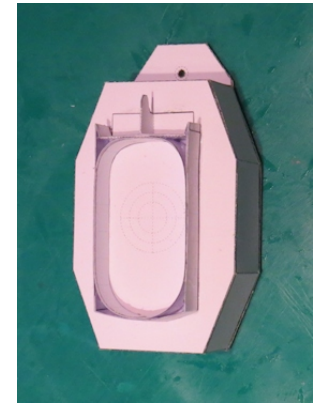

Auf diese Halterung können alle Sterne und Laternen gehangen werden, die für die mittlere Standardhalterung geeignet sind (z.B. Stern 906e und Laterne 831b).



Die Einzelteile sollten in der Reihenfolge der Nummerierung zusammgebaut werden.

Drucken Sie bitte die Seiten 2 bis 11 auf 160g Papier aus.

Für die Herstellung der Scheiben benötigen Sie zwei zusätzliche Blätter Transparentpapier - die Schablonen sind auf Seite 6 zu finden.

Projekt Bastelbogen
www.projekt-bastelbogen.de

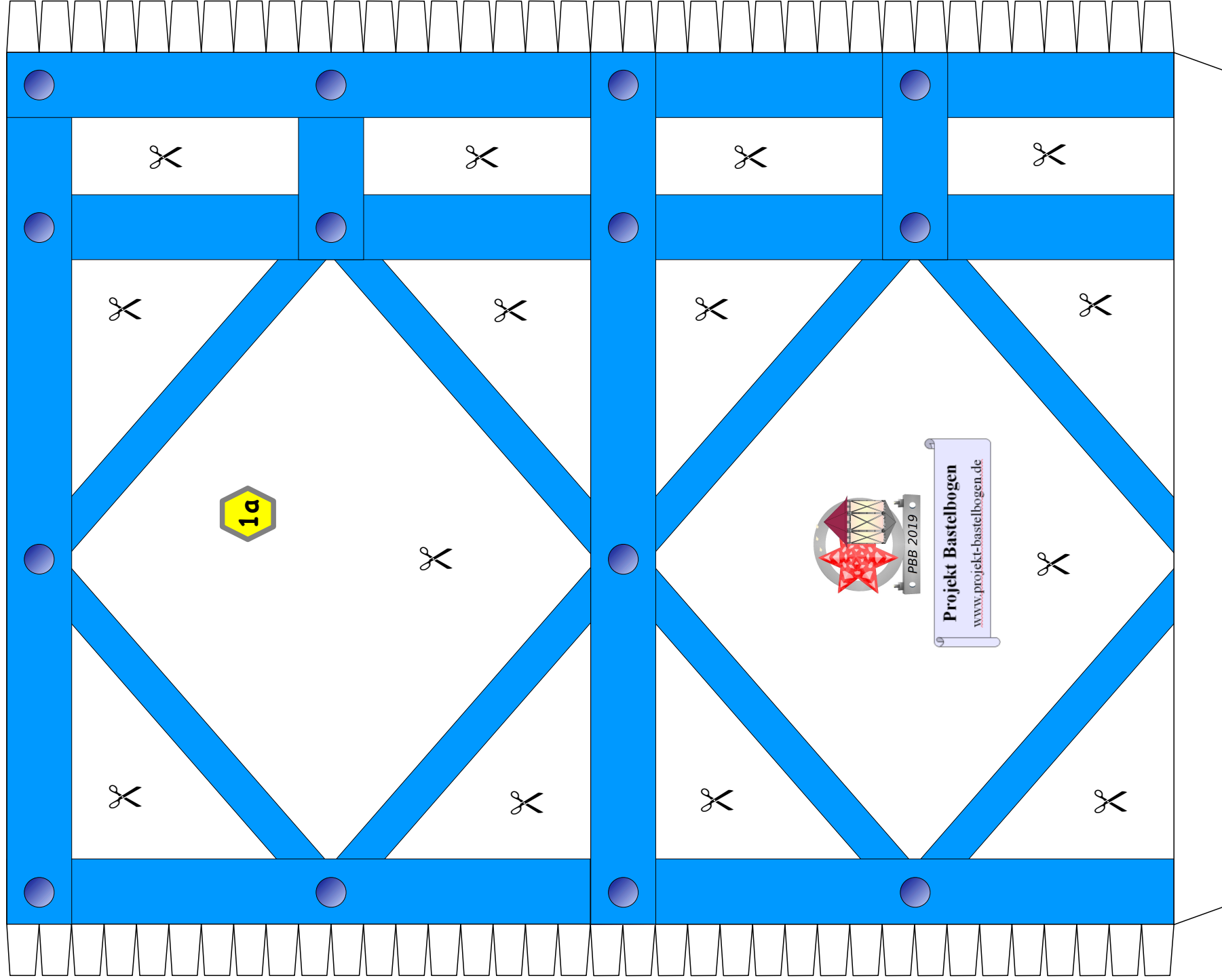

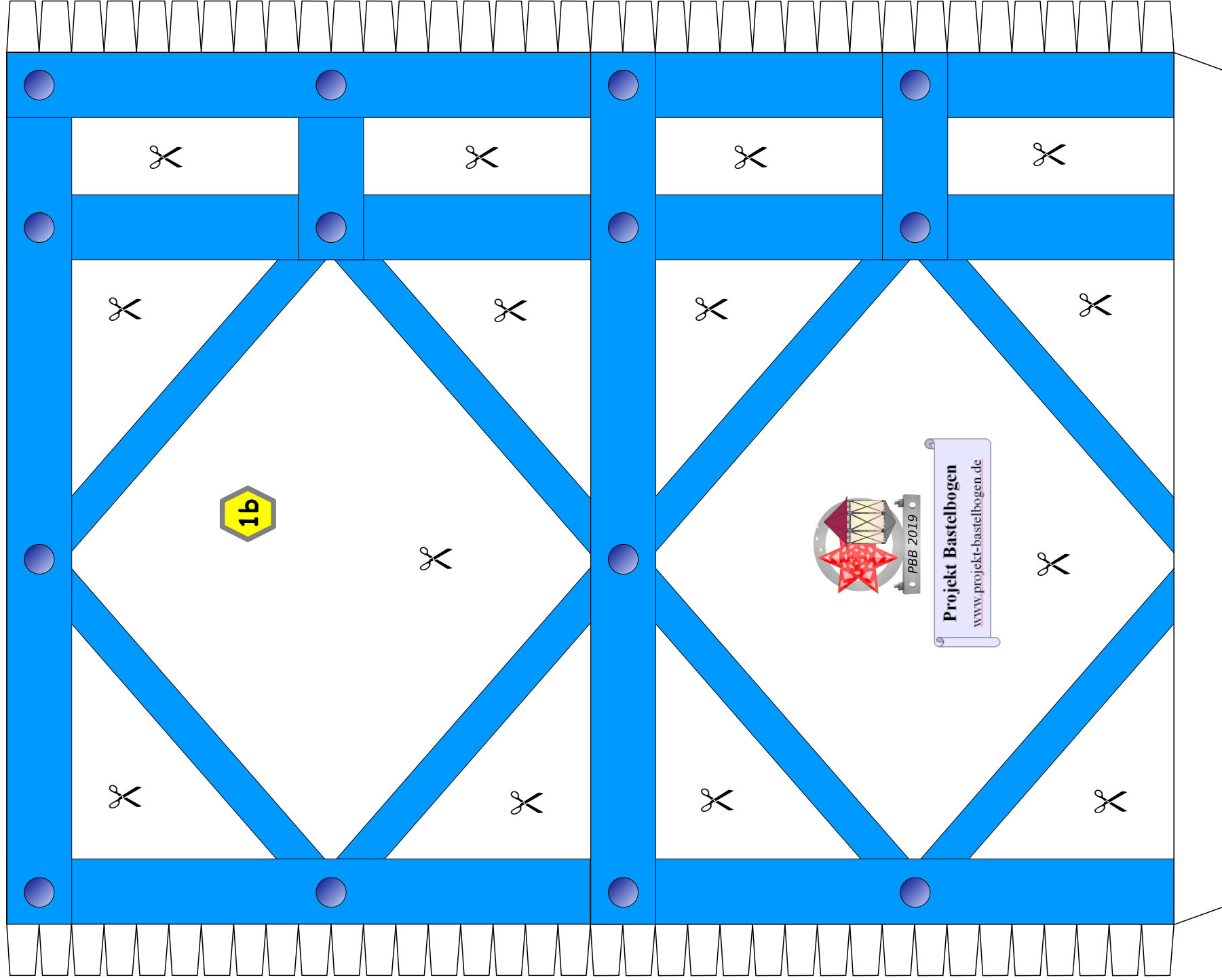

1c

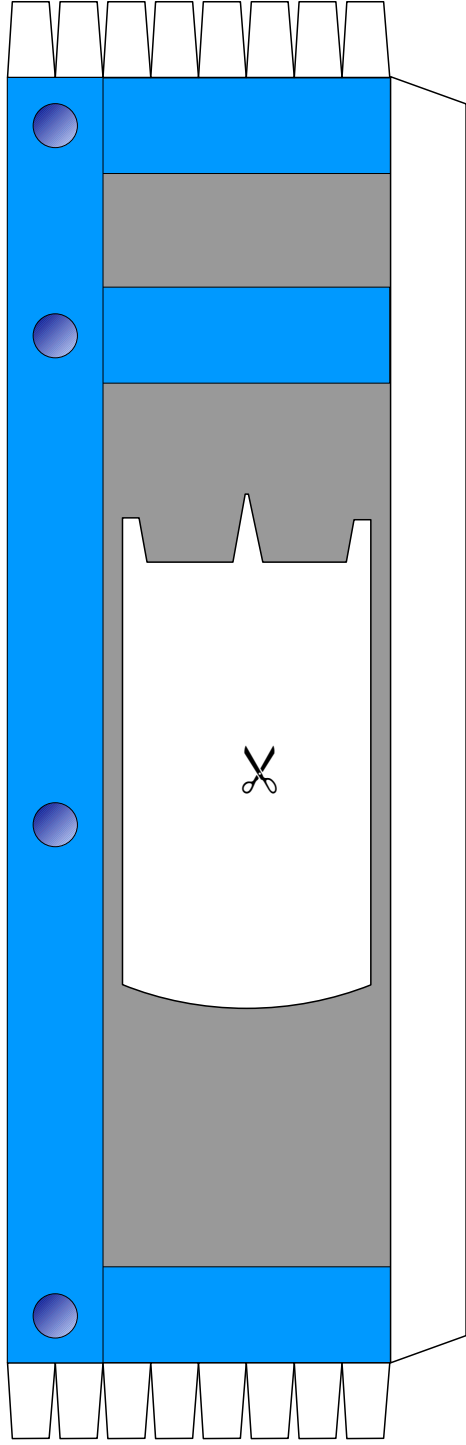

2a

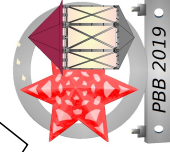
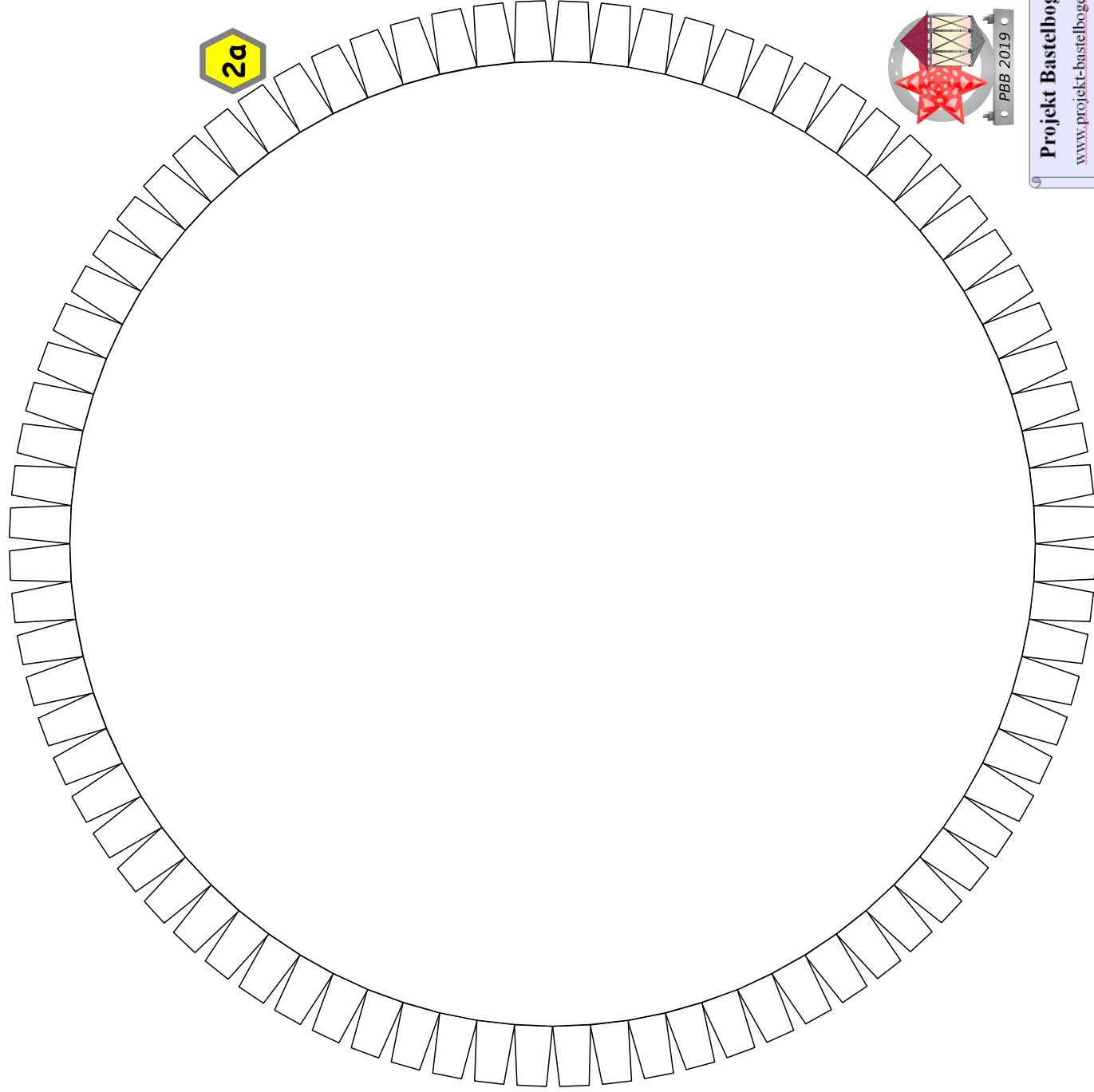

PBB 2019

Projekt Bastelbogen
www.projekt-bastelbogen.de

1d

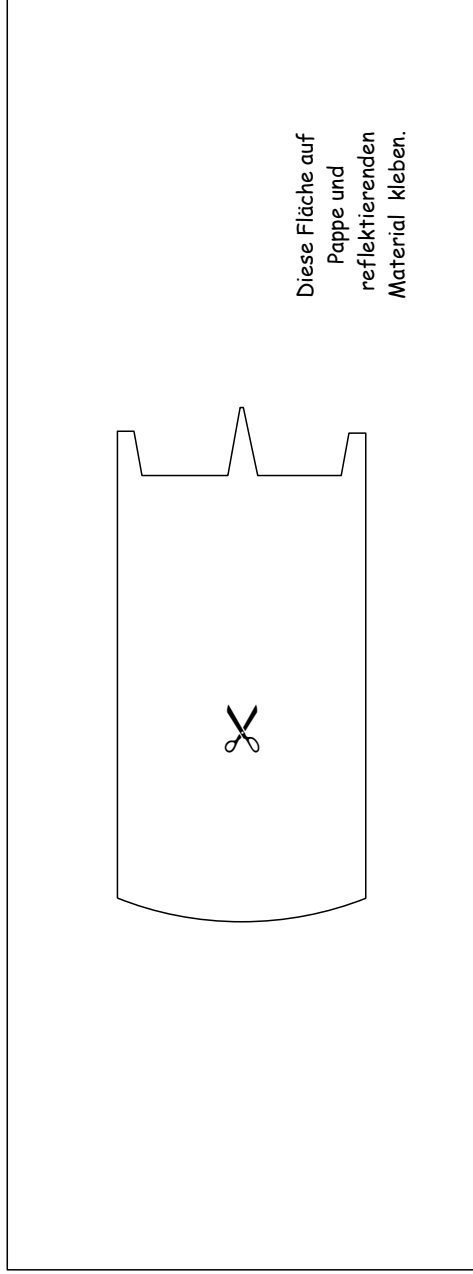

Diese Fläche auf
Pappe und
reflektierenden
Material kleben.

2b

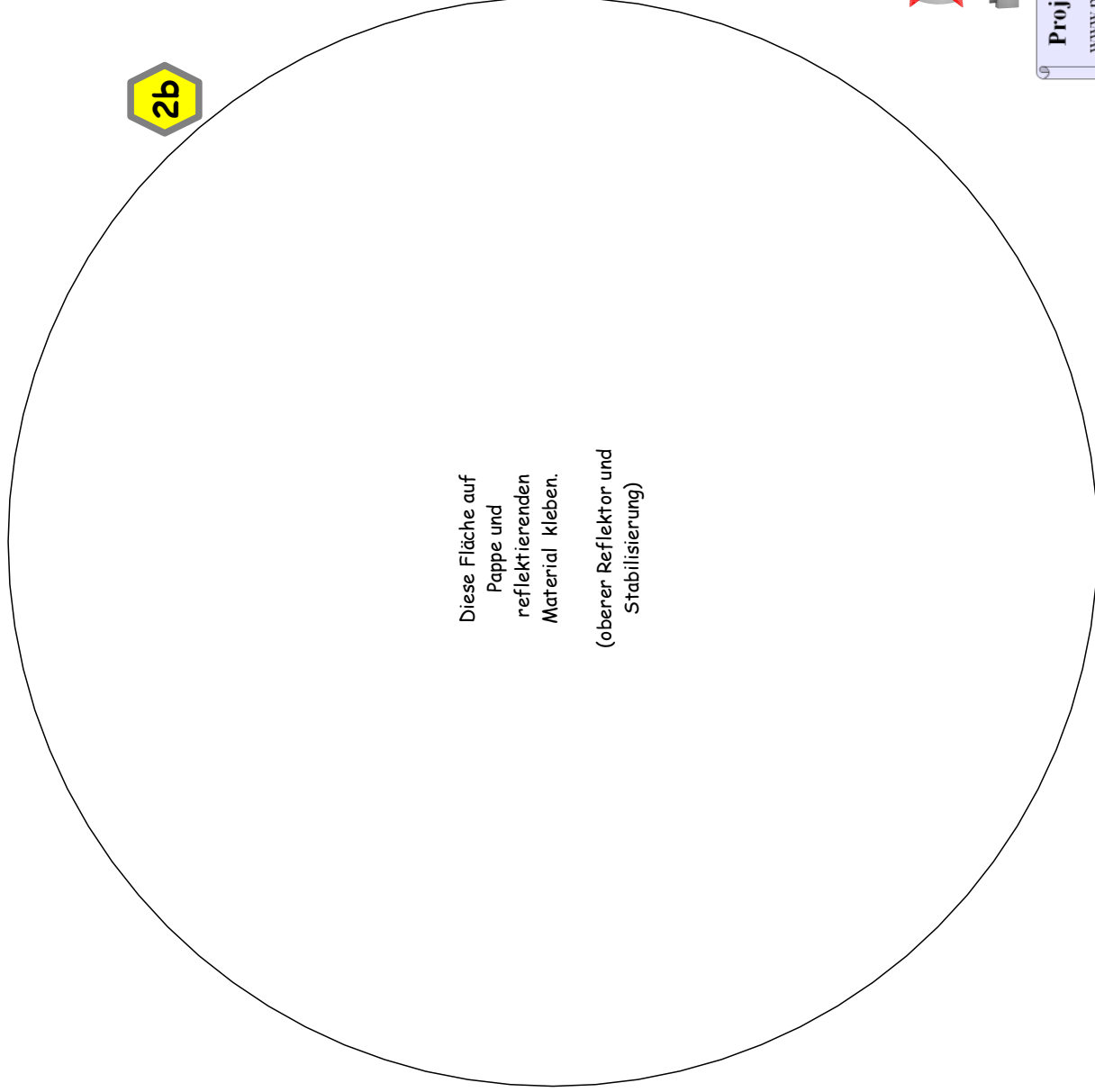

Diese Fläche auf
Pappe und
reflektierenden
Material kleben.
(oberer Reflektor und
Stabilisierung)

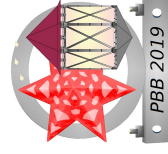

PBB 2019

Projekt Bastelbogen
www.projekt-bastelbogen.de

Schablonen für die
Scheiben der Laterne

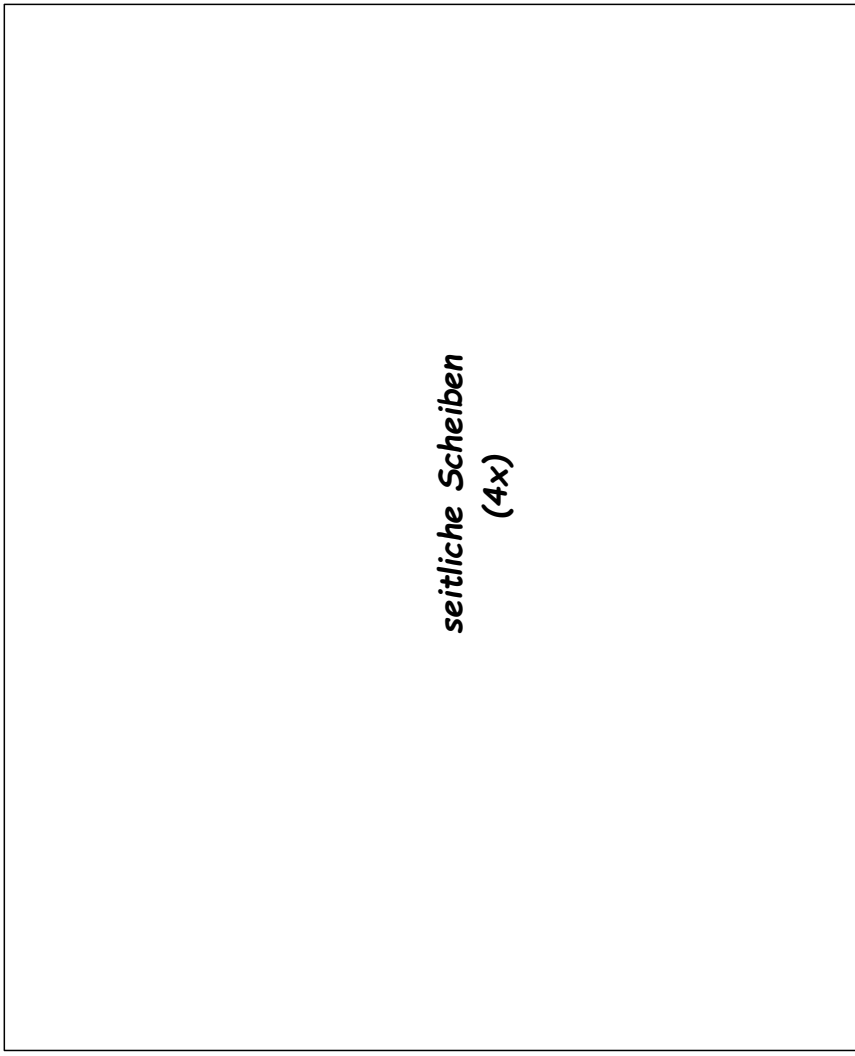

seitliche Scheiben
(4x)

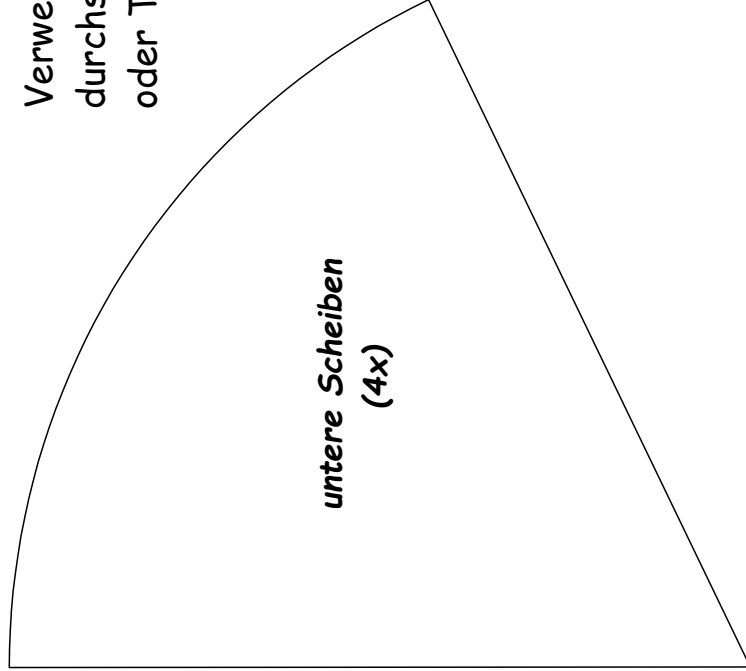

untere Scheiben
(4x)

4c

hintere untere Scheiben
(1x)

Verwenden Sie bitte für die Scheiben
durchsichtiges Kunststoffmaterial
oder Transparentpapier.

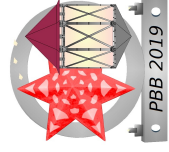

• PBB 2019 •

Projekt Bastelbogen
www.projekt-bastelbogen.de

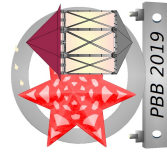
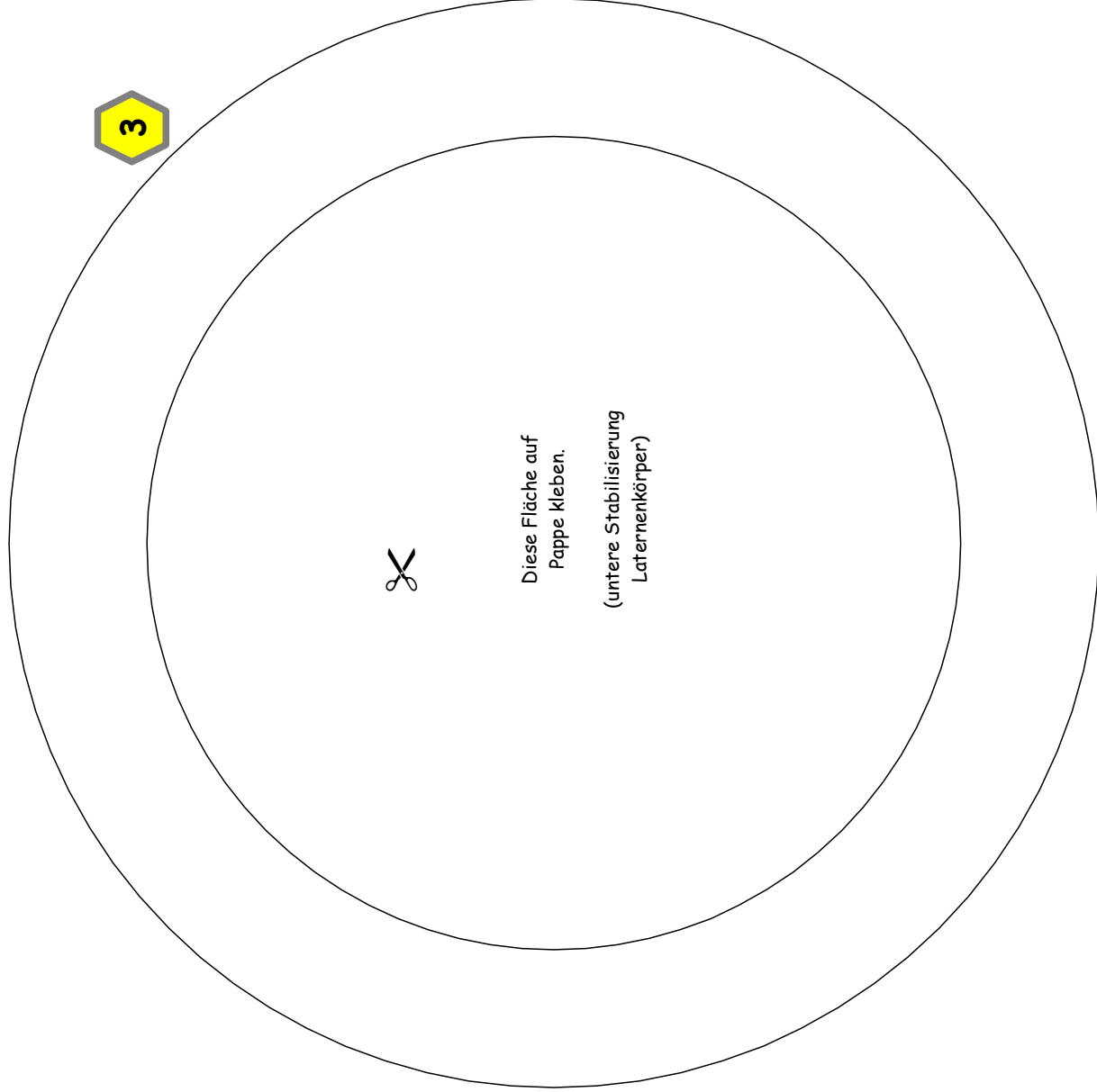

PBB 2019

Projekt Bastelbogen
www.projekt-bastelbogen.de

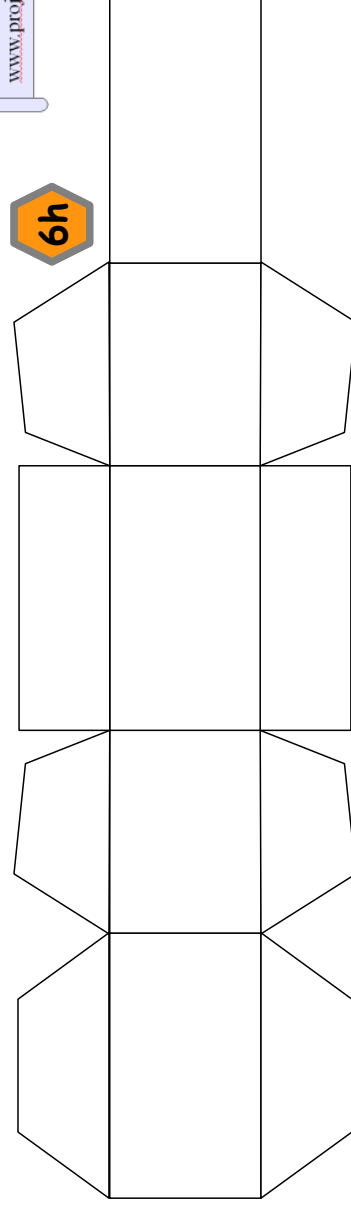

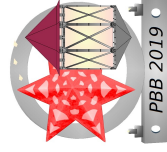
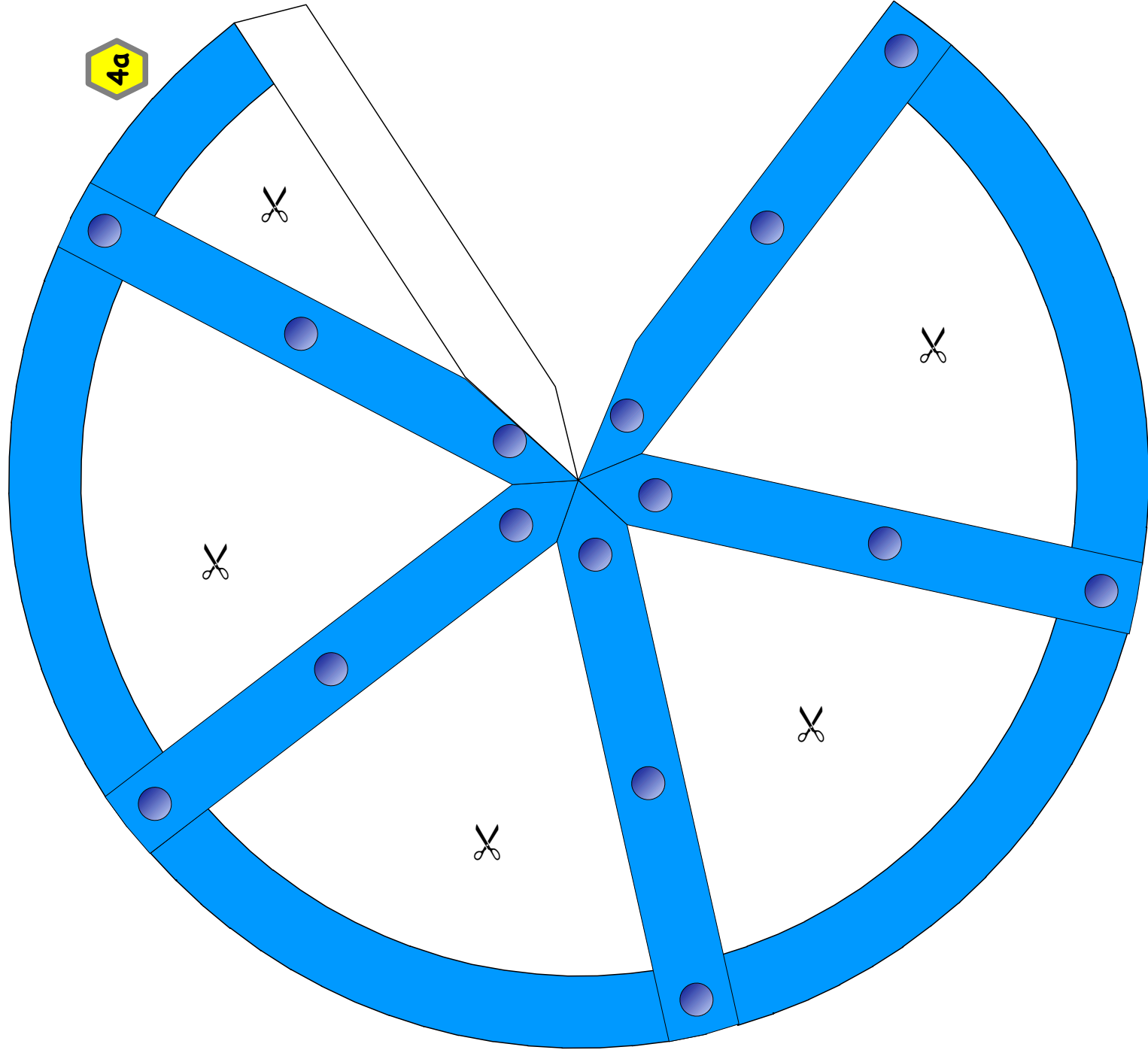

PBB 2019

Projekt Bastelbogen
www.projekt-bastelbogen.de

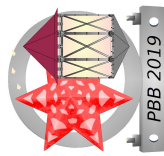
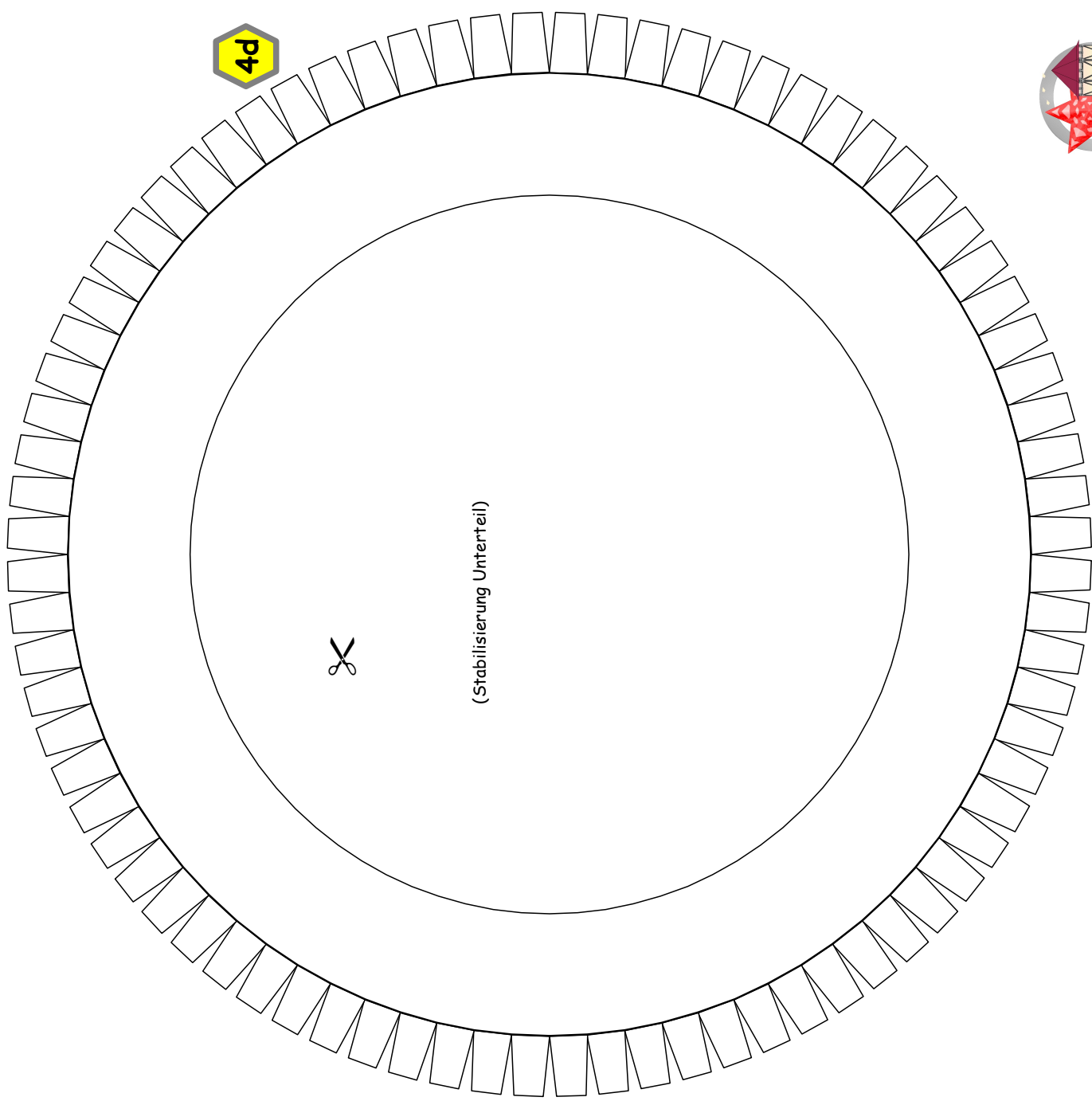

Projekt Bastelbogen
www.projekt-bastelbogen.de

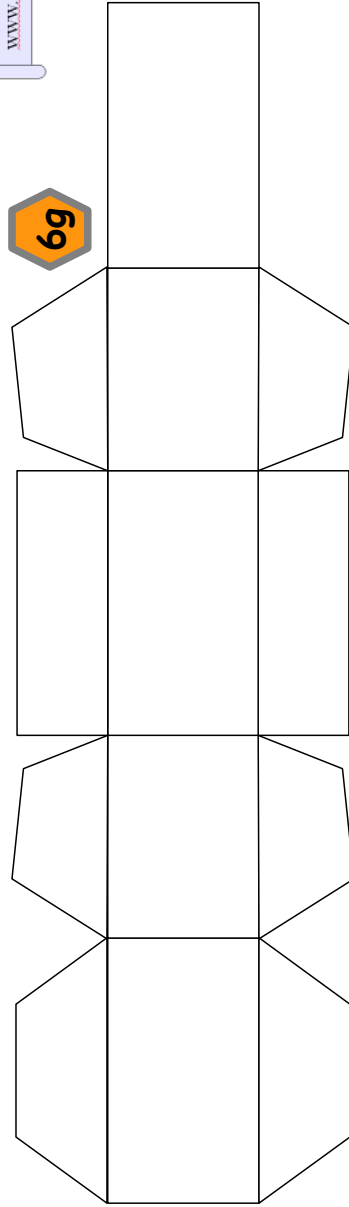

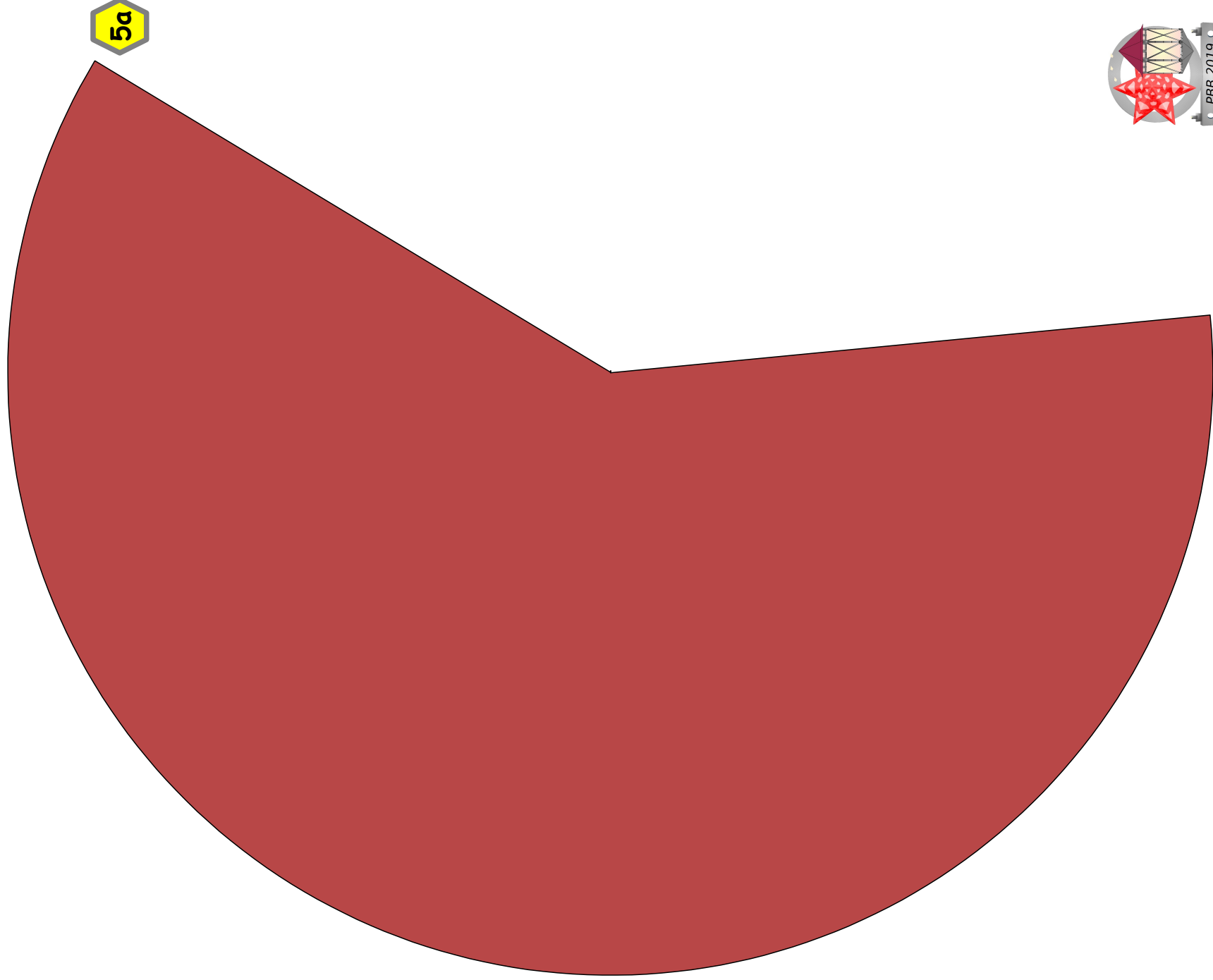

5a

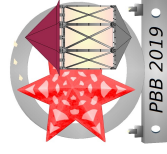

PBB 2019

Projekt Bastelbogen
www.projekt-bastelbogen.de

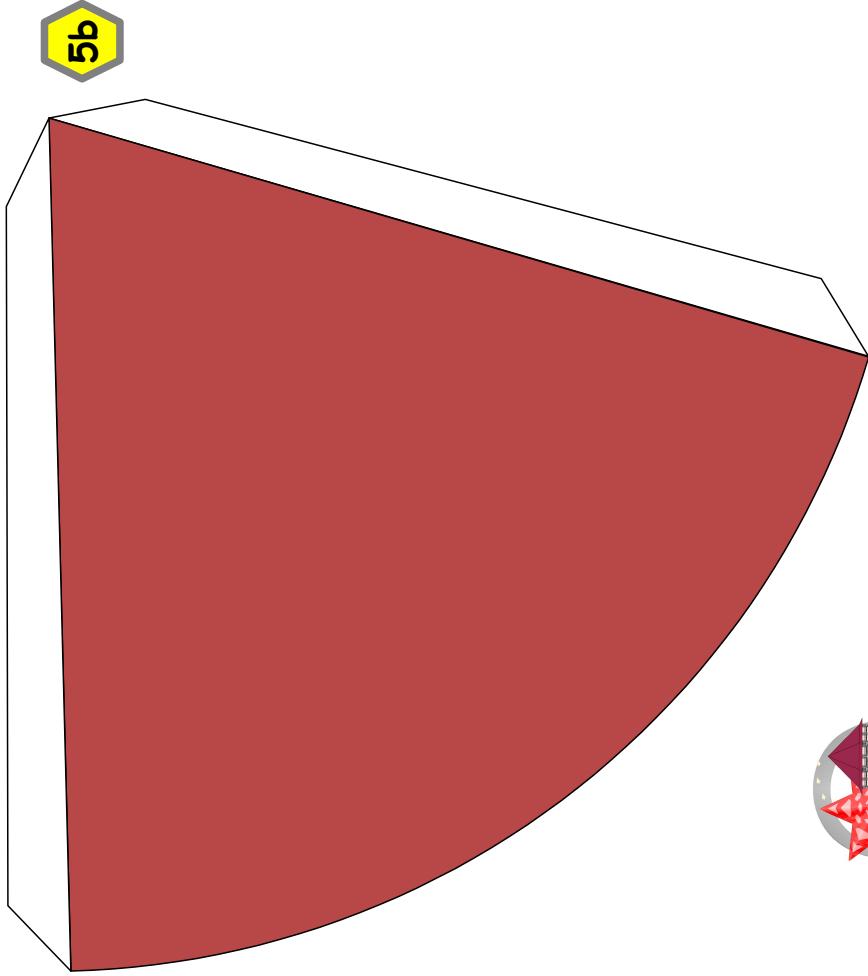

(Randverstärkung für Halterung)

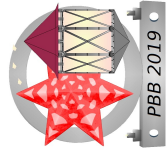
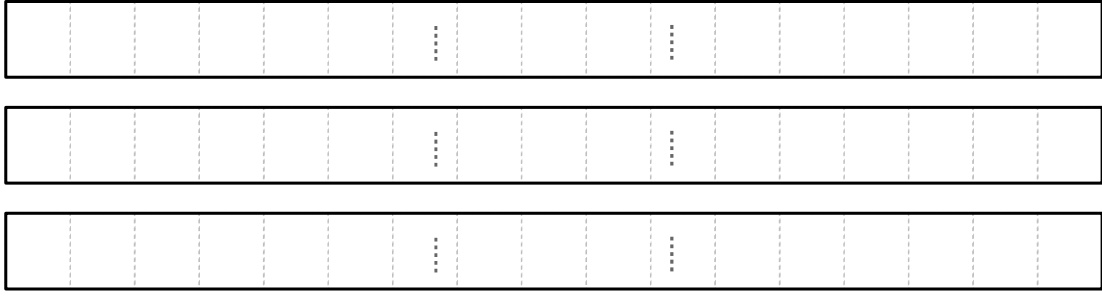

PBB 2019

Projekt Bastelbogen

www.projekt-bastelbogen.de

